

G65AC - Description et Caractéristiques

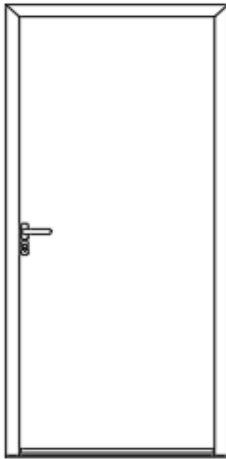

Dormant - 63 mm

Ouvrant Monobloc - 65mm

Isolation - polyuréthane injecté

Porte avec triple vitrage feuilleté

Seuil pour personne à mobilité réduite

Isolation Thermique Ud - **Ud ≤ 1,00 W/m².K**





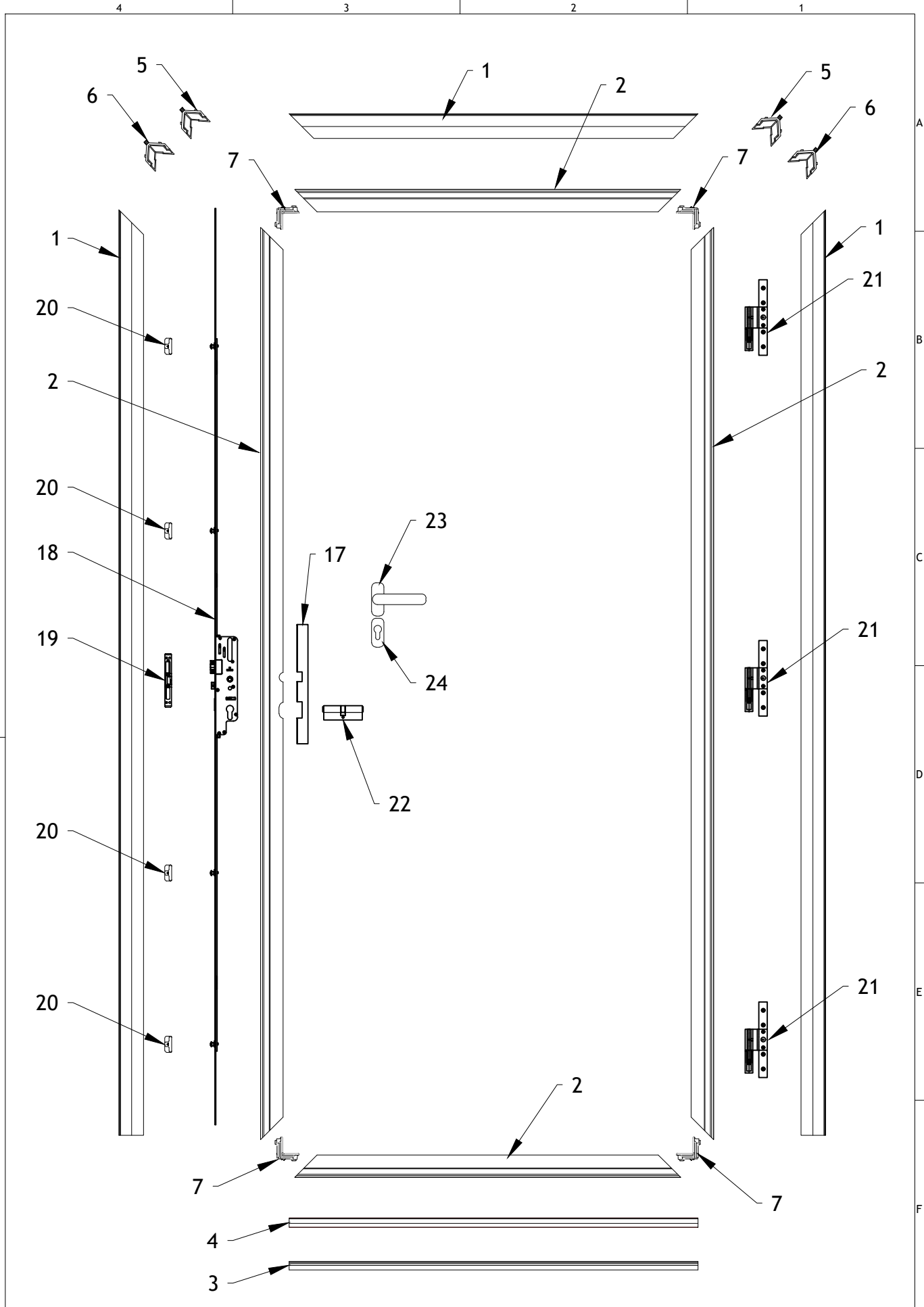





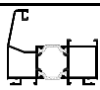
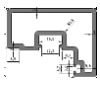





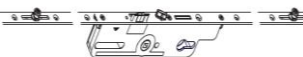
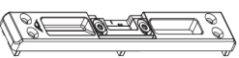
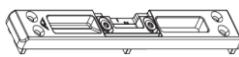

Isolation Acoustique - **31 dB**

Performance A*E*V - **4 * 7A* C5**











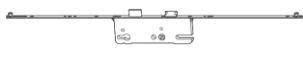

Desenho: Vasco S.	Data: 13/03/2024	Título: Porte d'entrée Acier	
Verificação:	Data:	Cliente:	Gama: G65AC
Aprovação:	Data:	Fase: Dv	Conteúdo: Vista Explodida
Escala: 1/2	Unidade: mm	Ficheiro: 3_G65AC_Explodida	Versão:
Tol. Geral: ± 1		Conteúdo: Vue Détaillée	
Formato: A4		N° Projeto: 2024.033	

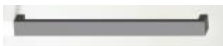









COMPOSANTS DE PORTA BASE

Cod	Article	Nom	Ref.	Qtd.	Cor
1		DORMANT	PM006	2H + 1L	EXT.+INT.
2		OUVRANT	P0393	2H + 2L	NA
3		SEUIL	PM023	1L	ANOD. NATURAL
4		REJET D'EAU	P0056	1L	ANOD. NATURAL
5		EQUERRE EXTÉRIEUR DU DORMANT	A0389	2	NA
6		EQUERRE INTÉRIEUR DU DORMANT	A0390	2	NA
7		EQUERRE DU OUVRANT	A0381	4	NA
14		JOINT DORMANT	P0516	2H + 1L	NOIR
15		JOINT OUVRANT	P0615	2H + 2L	NOIR
16		JOINT REJET D'EAU	P0493	1L	NOIR
17		ACCESSOIRE DE SERRURE	AM148	1	NA
18		SERRURE 6 POINTS ROULEAUX H620 FASTEO 4V 35/70	A0445	1	NA
19		GÂCHE DE LA SERRURE DROIT	A0473	1	NA
20		GÂCHE DE LA SERRURE GAUCHE	A0474	1	NA
20		POINT D'ANCRAGE	A0450	4	NA
21		PAUMELLE	A0653	3	9016MT - portes 9016STR 9005MT - portes Autres Couleurs
22		CYLINDRE 45/45 - 3clés	A0231	1	NA
23		DOUBLE POIGNÉE	A1033	1 par	9016MT - portes 9016STR 7016MT - portes 7016STR Imitation INOX - Autres COULEURS
24		CACHE CYLINDRE	A0560	1 par	9016MT - portes 9016STR 7016MT - portes 7016STR Imitation INOX - Autres COULEURS
25		CARRÉ DE POIGNÉE 85X8X8	A0985	1	NA
26		PATTE DE FIXATION	A0385	10	NA
27		CACHE TROUS	A0446	10	NOIR

COMPOSANTS PORTE AVEC TIRANT

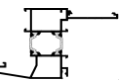
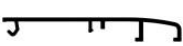
28		SERRURE 6 POINTS ROULEAUX 35/92/8 F16 2200 C Manual	A1234	1	N/A
29		TIRANT PX01 (300x25)	A0307	1	INOX
30		TIRANT PX02 (657x25)	A0434	1	INOX
31		TIRANT PX03 (1500x30)	A0435	1	INOX
32		TIRANT PY01 (500x40x20)	A0288	1	INOX
33		TIRANT PZ01 (1400x40x20)	A0289	1	INOX
34		TIRANT PQ01 (600x30x30)	A0431	1	INOX
35		TIRANT PQ02 (1400x30x30)	A0432	1	INOX
36		DOUBLE POIGNÉE INOX	A0051	1	INOX
37		CACHE CYLINDRE - OVAL INOX	A0048	1	INOX

AUTRES COMPOSANTS

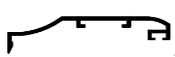
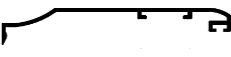
38		PROFIL "T" POUR IMPOSTE	P0082	...	INT. / EXT.
39		PROFIL "T" RENFORT POUR TIERCE	P0076	...	EXTÉRIEUR
40		PARCLOSE POUR VITRAGE	P0108	2H	INTÉRIEUR
41		PARCLOSE POUR VITRAGE	P0105	2L	INTÉRIEUR
42		JOINT EXTERIEUR POUR VITRÉE LATERAL ET IMPOSTE	P0400	2H + 2L	NOIR
43		JOINT INTÉRIEUR POUR VITRÉE LATERAL ET IMPOSTE	P0522 / P0523	2H + 2L	NOIR
44		DORMANT RENOVATION	PM050	2H + 1L	EXT. + INT.
45		PROFIL FINITION INTÉRIEUR RENOVATION 70mm	P0071	2H + 1L	INTÉRIEUR
46		PROFIL FINITION INTÉRIEUR RENOVATION 40mm	P0070	2H + 1L	INTÉRIEUR
47		PROFIL FINITION INTÉRIEUR 30mm	P0066	2H + 1L	INTÉRIEUR
48		PROFIL FINITION INTÉRIEUR OUTROS 40mm	P0067	2H + 1L	INTÉRIEUR
49		PROFIL FINITION INTÉRIEUR 60mm	P0068	2H + 1L	INTÉRIEUR
50		PROFIL FINITION INTÉRIEUR 85mm	P0069	2H + 1L	INTÉRIEUR

51		TAPÉE 100	P0087	2H + 1L	EXTÉRIEUR
52		SUPPORT TAPÉE 100	A0377	10	N/A
53		TAPÉE 120	P0088	2H + 1L	EXTÉRIEUR
54		SUPPORT TAPÉE 120	A0378	10	N/A
55		SUPPORT TAPÉE 140	P0089	2H + 1L	EXTÉRIEUR
56		SUPPORT TAPÉE 140	A0379	10	N/A
57		TAPÉE 160	P0090	2H + 1L	EXTÉRIEUR
58		SUPPORT TAPÉE 160	A0380	10	N/A
59		TAPÉE 180	P0091	2H + 1L	EXTÉRIEUR
60		SUPPORT TAPÉE 180	A0381	10	N/A
61		DOUBLE POIGNÉE INOX	A0438	1	INOX
62		CYLINDRE BOUTON MOLETÉ	A1506	1	INOX
63		CYLINDRE DÉBRAYABLE	A1507	1	N/A
64		CYLINDRE AVEC CARTE PROPRIÉTÉ	A1505	1	NA
65		GACHE PIVOTANTE DEBRAYABLE	A0427	1	N/A
66		GACHE ELÉTRIQUE	A0427	1	N/A

4

3

2

1

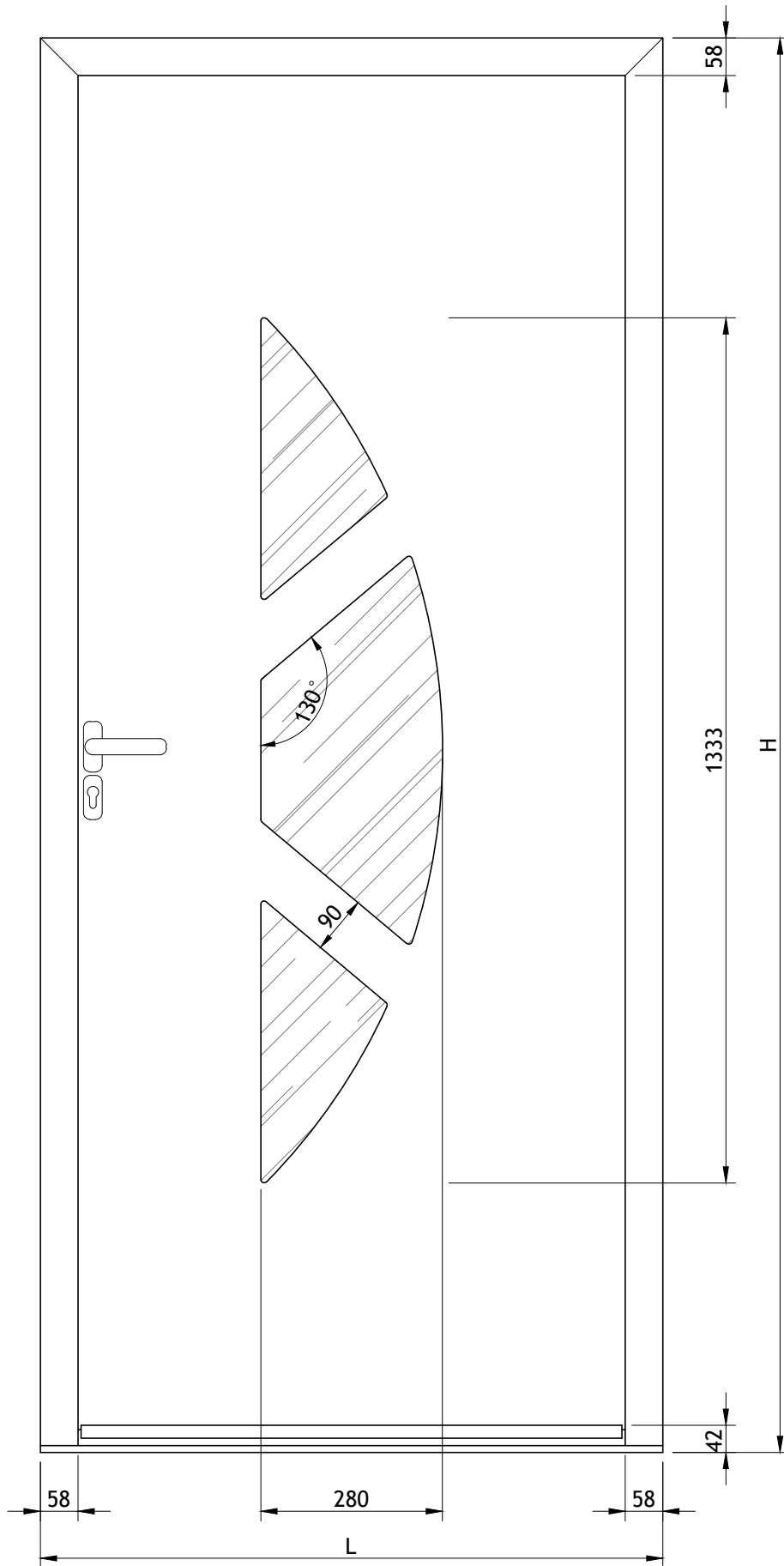

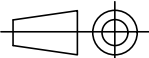
 Vidro	Dim. STD 2180x960		
Desenho: Diogo G.	Data: 21/05/2025	Título: Porta de entrada em Aço	
Verificação:	Data:	Cliente:	Gama: G65AC
Aprovação:	Data:	Fase: DV	Modelo: Víseu
Escala: 1/10	Unidade: mm	Ficheiro: G65AC_ModELOS	Versão: 1.1.1
Tol. Geral: ± 1		Conteúdo: Vista Frontal	Nº Projeto: 2022.05
Formato: A4			