

G70FO - Description et Caractéristiques



Dormant - 70 mm

Ouvrant Monobloc - 52 mm

Isolation - Poliestirene (XPS)

Porte avec triple vitrage feuilleté

Seuil pour personne à mobilité réduite

Isolation Thermique Ud - **Ud ≤ 1,11 W/m2.K**





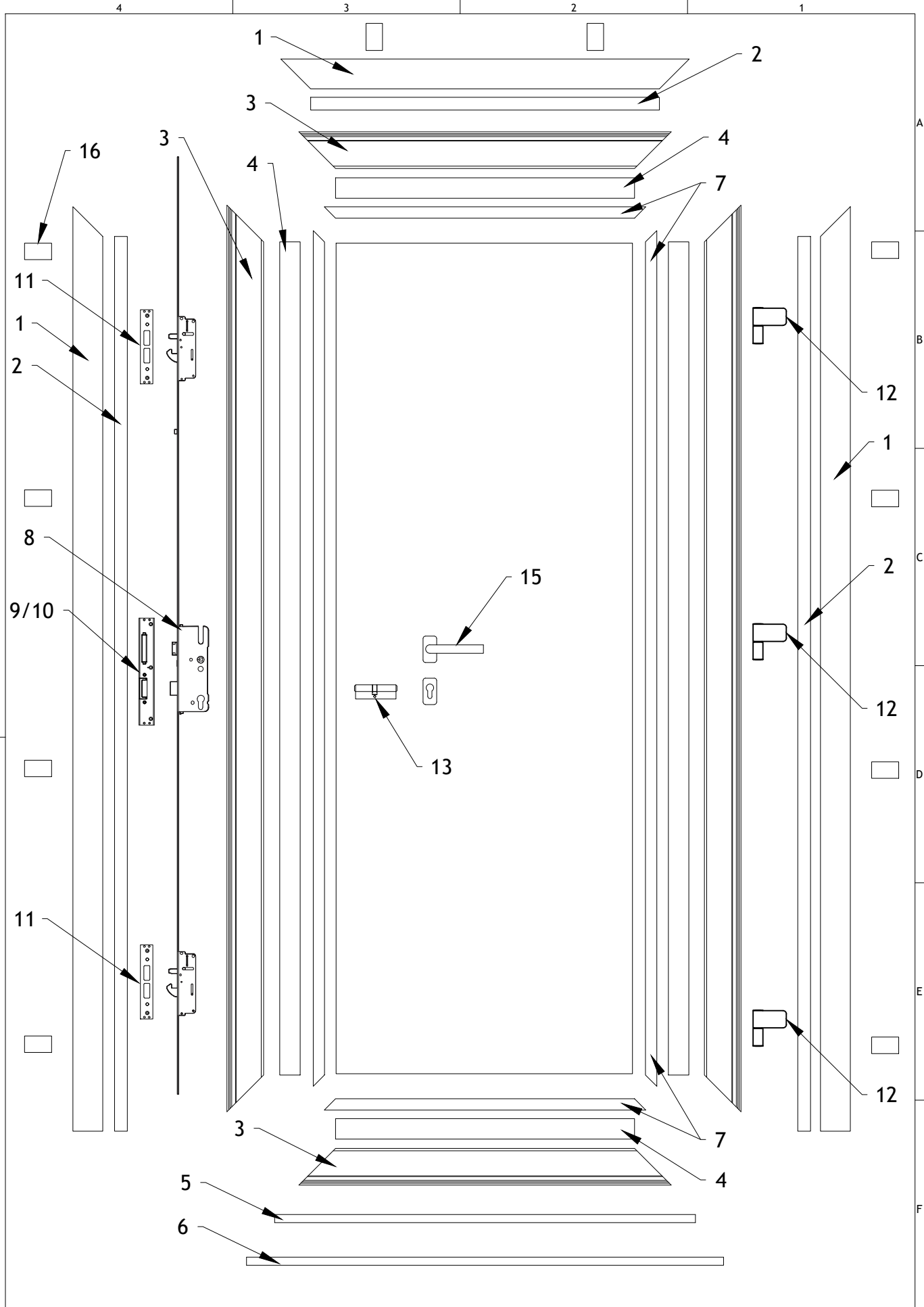

















Isolation Acoustique - **28 dB**

Performance A*E*V - **3 * 3A* C5**













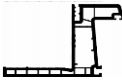

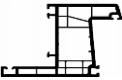

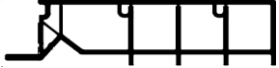
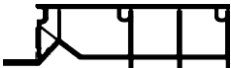















Desenho: Diogo G.	Data: 18/09/2023	Título: Gamme 70FO	
Verificação:	Data:	Cliente:	Gama: G70FO
Aprovação:	Data:	Fase: Desenvolvimento	Conteúdo: Section Porta STD
Escala: 1/2	Unidade: mm	Ficheiro: 3_G70FO_Explodida	Versão:
Tol. Geral: ± 1		Conteúdo: Vue Détaillée	
Formato: A4		N° Projeto: 2023.01	

G70FO - CONSTITUTION DE PORTE

COD	ARTICLE	NOM	RÉFÉRENCE	QTD.
1		DORMANT	P0377	2H + 1L
2		RENFORCEMENT DORMANT	P0387	2H + 1L
3		OUVRANT	P0379	2H + 2L
4		RENFORCEMENT OUVRANT	P0456	2H + 2L
5		REJET D'EAU	P0491	1L
6		SEUIL	PM022	1L
7		PARCLOSE PANNEAU	P0385	2H + 2L
8		SERRURE DE 6 POINTS MANUEL À CROCHET	A0506	1
9		GÂCHE DE LA SERRURE DROIT	A0470	1
10		GÂCHE DE LA SERRURE GAUCHE	A0471	1
11		POINT D'ANCORAGE	A0472	2
12		PAUMELLE	A0424	3
13		CYLINDRE SÉCURITÉ 45/50 (5 CLÉS)	A0486	1
14		ANTI-DEGONDAGE	A0411	3
15		POIGNÉE + CACHE DU CILYNDRE (rectangulaire)	A0580	1
16		PATTE DE FIXATION	A0385	10
17		VIS DE FIXATION SEUIL + REJET D'EAU DIN 7982 A. INOX 3,5X25	A0350	2 + 3
18		VIS DE FIXATION SEUIL DIN 7982 A. INOX 3,5X32	A0322	2
19		VIS DE FIXATION CACHE ET SERRURE DIN 7982 A. INOX 4,2X19	A0151	4 + 4 + 10
20		VIS DE FIXATION GÂCHE DU SERRURE DIN 7982 A. INOX 4,2X35	A0361	7
21		JOINT REJET D'EAU	P0492	2L
22		RENFORCEMENT HPL	F168	1H

G70FO - AUTRES OPTIONS

COD	ARTICLE	NOM	RÉFÉRENCE	QTD.
23		PROFIL "T" POUR TIERCE OU IMPOSTE	P0381	1H
24		RENFORCEMENT POUR "T"	P0390	1H
25		PARCLOSE POUR TIERCE ET IMPOSTE	P0382	2H + 2L
26		DORMANT DE RENOVATION	P0380	2H + 1L
27		RENFORCEMENT POUR DORMANT DE RENOVAT	P0388	2H + 1L
28		DORMANT POUR TAPÉE	P0378	2H + 1L
29		RENFORCEMENT POUR DORMANT POUR TAPÉE	P0391	2H + 1L
30		RENFORCEMENT HPL	F168	2H + 1L
31		TAPÉE 160mm	P0383	2H + 1L
32		TAPÉE 140mm	P0383	2H + 1L
33		TAPÉE 120mm	P0383	2H + 1L
34		TAPÉE 100mm	P0383	2H + 1L
35		SUPPORT TAPÉE 100	AP110	10
36		SUPPORT TAPÉE 120	AP109	10
37		SUPPORT TAPÉE 140	AP108	10
38		SUPPORT TAPÉE 160	A0394	10
39		PROFIL EXTÉRIEUR POUR RENOVATION	P0384	2H + 1L
40		CILINDRE DOUBLE DÉBRAYAGE	A0504	1
41		CILINDRE À BOUTON	A0485	1
42		CILINDRE CARTE PROPRIÉTÉ	A0501	1
43		GÂCHE DÉBRAYABLE	A0427	1

44		GACHE ELÉTRIQUE	A0427	1
45		DOUBLE POIGNÉE CINTRÉE	A0442	1
46		DOUBLE POIGNÉE CARRÉE	A0340	1
47		DOUBLE POIGNÉE	A0438	1
48		TIRANT PX01 (300x25)	A0307	1
49		TIRANT AC02	A0272	1
50		TIRANT AC03	A0271	1
51		TIRANT PY01 (500x40x20)	A0288	1
52		TIRANT PQ01 (600x30x30)	A0431	1
53		TIRANT PX02 (657x25)	A0434	1
54		TIRANT PZ01 (1400x40x20)	A0289	1
55		TIRANT PQ02 (1400x30x30)	A0432	1
56		TIRANT PX03 (1500x30)	A0435	1

4

3

2

1

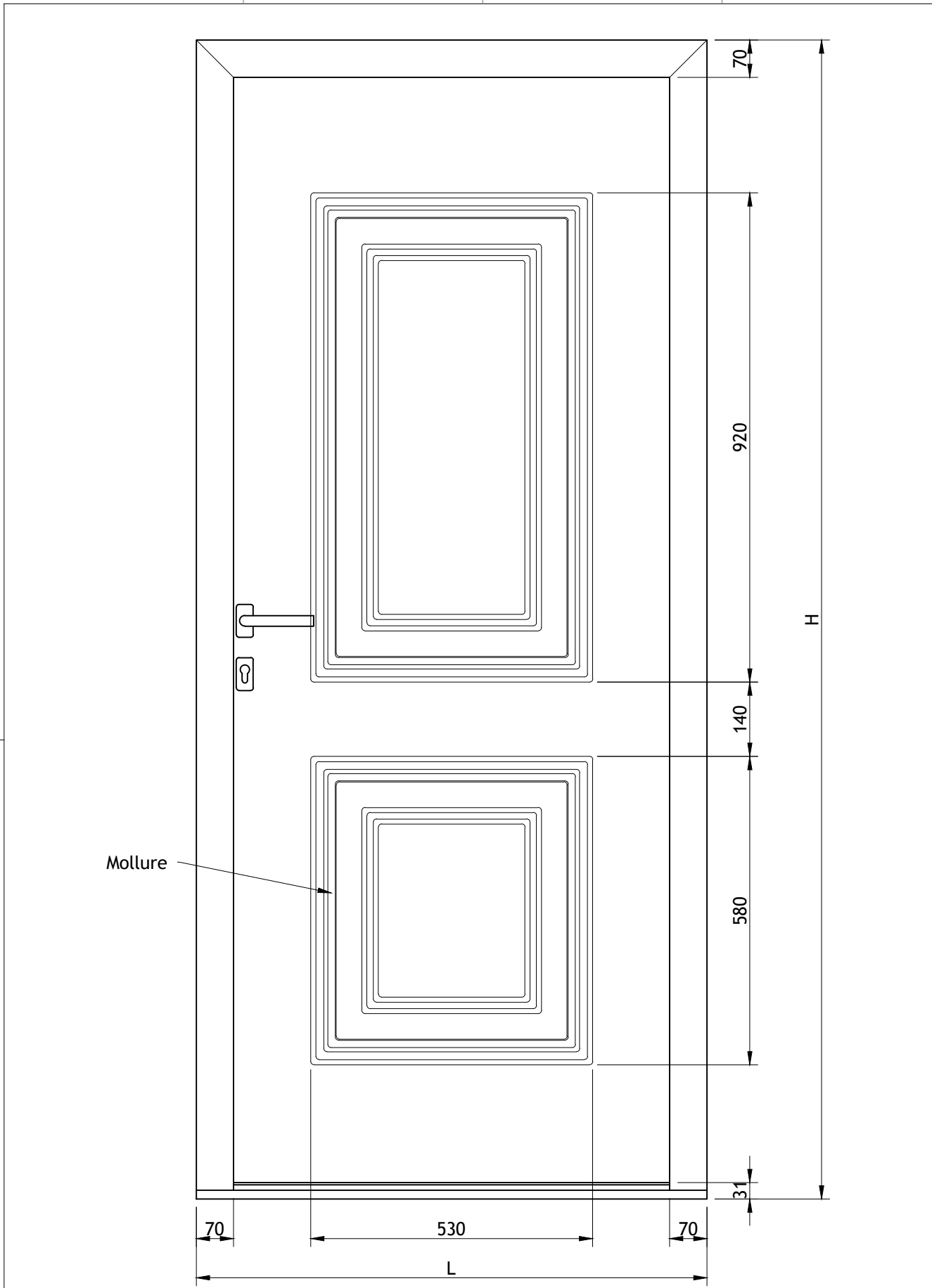

Mollure

70

530

70

L

70

920

140

580

31

H

A
B
C
D
E
F

Dim. STD 2180x960

Desenho: Diogo G.		Data: 14/08/2024	Título: Modelos Classic	
Verificação:	Data:	Cliente:	Gama: G70FO	
Aprovação:	Data:	Fase: DV	Modelo: Lamego	
Escala: 1/10	Unidade: mm	Ficheiro: 8.1_G70FO_Modelos_Classic	Versão:	
Tol. Geral: ± 0,5		Conteúdo: Vista Frontal		dossier: GG_2023.01
Formato: A4				